

LDO

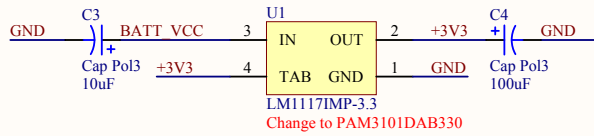

USB Charger

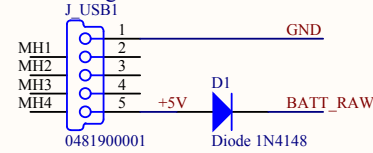

BATT_VCC

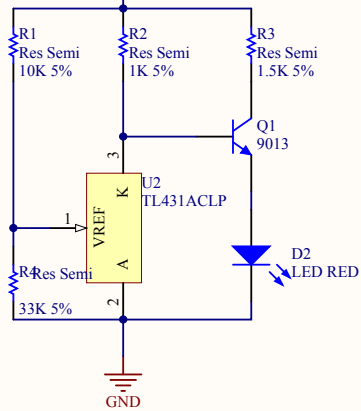

Low Power Detector

Poly-Li Input

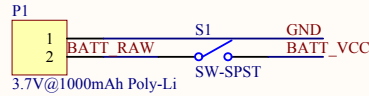

GPS module

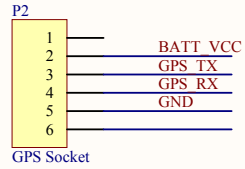

Bluetooth Debug Port

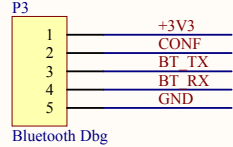

Bluetooth Module

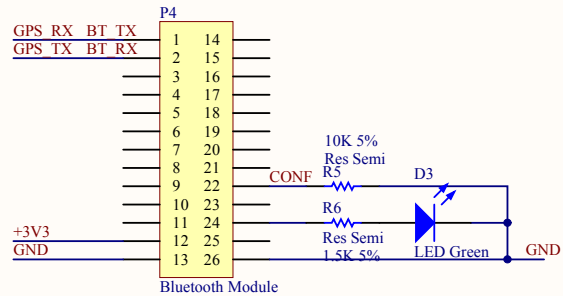

Title		
EZ-Bluetooth GPS by CSK		
Size	Number	Revision
A4		
Date:	2010/8/28	Sheet of
File:	D:\eskssoft\...\GPS+bluetooth.SchDoc	Drawn By: